

System Furniture
Free Standing

Correctional Industries
June 2009 Revised December 2010

FlexStation Pricing Guide
Metal Base Desk System

Effective **March 2011** this publication replaces all previous
Freestanding System Furniture Catalog Price Lists.
All prices and specifications are subject to change without notice.



FlexStation Typical Metal Base Workstations

Additional charge (includes inside delivery) will apply for scheduled installation.

Workstation #1 Non-powered

Item	Model #	Price	D	W	H	Page
Basic Worksurface	WBW3060XX9NWS	\$296	30"	60"	29"	4
Overhead Cabinet	WZUL60	\$444	14.5"	60"	36"	9
Privacy Screens (2)	WZOP60	\$267	-	60"	19"	10
Mobile Pedestal (F/F)	CIP1530MFF	\$293	28"	15"	27.75"	-
Total: \$1,300						

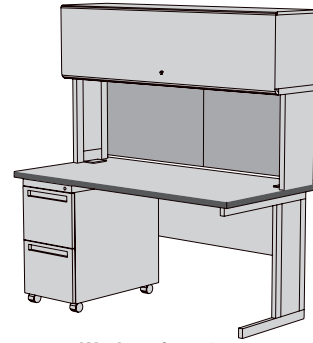

Workstation #1
5' x 2.5'

Workstation #2 Non-powered

Item	Model #	Price	L/R	D	W	H	Page
Basic Worksurface (x2)	WBW3060XX9NWS	\$592		30"	60"	29"	4
Overhead Cabinet (x2)	WZUL60	\$888		14.5"	60"	36"	9
Corner Worksurface	WCS3042XX9NWS	\$431		30"/30"	42"	29"	5
Corner Privacy Screens (2)	WZP2442	\$355		-	42"	19"	10
Privacy Screens (2)(x2)	WZOP60	\$534		-	60"	19"	10
Mobile Pedestal (P/B/F)(x2)	CIP1530MPBF	\$638		28"	15"	24.75"	-
Total: \$3,438							

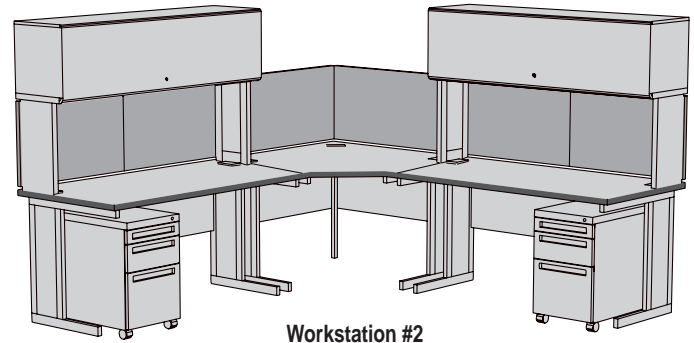

Workstation #2
8.5' x 8.5'

Workstation #3 Non-powered

Item	Model #	Price	L/R	D	W	H	Page
Basic Worksurface (x2)	WBW3048XX9NWS	\$554		30"	48"	29"	4
Corner Worksurface	WCS3048XX9NWS	\$453		30"/30"	48"	29"	5
Overhead Cabinet	WZUL48	\$386		14.5"	60"	36"	9
Privacy Screens	WZOP48	\$181		-	48"	19"	10
Lateral File Cabinet	CIL302402D	\$280		18"	30"	27"	-
Total: \$1,854							

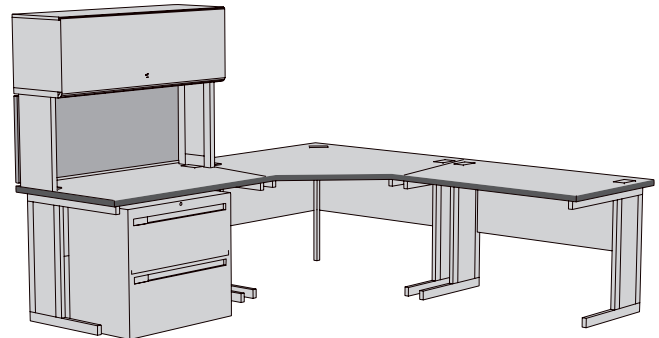

Workstation #3
8' x 8'

Typical Metal Base Workstations FlexStation

Additional charge (includes inside delivery) will apply for scheduled installation.

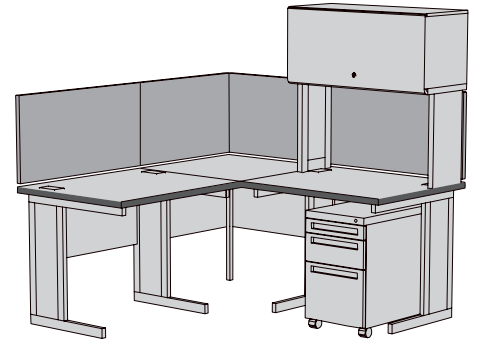

Workstation #4
5.5' x 5.5'

Workstation #4 Non-powered

Item	Model #	Price	D	W	H	Page
Basic Worksurfaces (x2)	WBW3036XX9NWS	\$592	30"	36"	29"	4
Transitional Corner, Square	WST3030XX99NW	\$169	30"	30"	29"	7
Overhead Cabinet	WZUL36	\$359	14.5"	60"	36"	9
Privacy Screen (Left)	WZP36	\$147	-	36"	19"	10
Privacy Screen (Right)	WZOP36	\$155	-	36"	19"	10
Corner Privacy Screens (2)	WZPS3030	\$187	-	30"	19"	10
Mobile Pedestal (P/B/F)	CIP1530MPBF	\$319	28"	15"	24.75"	-

Total: \$1,928

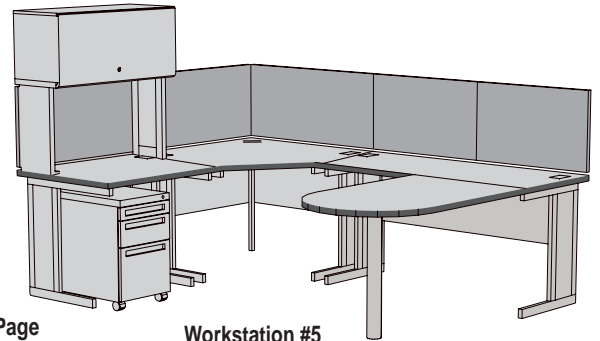

Workstation #5
6.5' x 8.5'

Workstation #5 Non-powered

Item	Model #	Price	L/R	D	W	H	Page
Basic Worksurface (Left)	WBW3036XX9NWS	\$265		30"	36"	29"	4
Basic Worksurface (Right)	WBW2460XX9NWS	\$291		24"	60"	29"	4
Corner Reduction	WCS304224XX9NWS	\$399		30"/24"	42"	29"	6
Peninsula, End Mount	WPW3048XX9NW	\$223		30"	48"	29"	8
Overhead Cabinet	WZUL36	\$359		14.5"	60"	36"	9
Privacy Screens (2, Right)	WZP60	\$255		-	60"	19"	10
Privacy Screen (Left)	WZOP36	\$155		-	36"	19"	10
Corner Privacy Screens (2)	WZP2442	\$355		-	42"	19"	10
Mobile Pedestal (P/B/F)	CIP1530MPBF	\$319		28"	15"	24.75"	-

Total: \$2,621

FlexStation Typical Metal Base Workstations

Required for Order: Model number, Laminate finish choice, Edge type choice, Trim color choice

Basic Worksurface

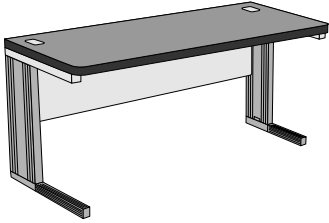

Standard Features

- 1 1/4" solid core top with high pressure laminate finish
- Please specify edge type: T-mold or 3mm PVC
- Each leg is a welded unit joined by a modesty panel; leg cavity provides concealed management of wire from floor to worksurface
- 16 gauge seam-welded tubular steel frame with 19 gauge steel modesty panel
- 3" x 2" wire management port with protected edges, on both sides at top of modesty panel
- Non-chipping enamel finish on legs and modesty
- Scuff plates
- Adjustable chrome plated leveling glides
- Two grommets

* Includes wireway trough affixed to top of modesty panels

Type	Model#	Price	D	W	H
Basic	WBW2436XX9NWS	\$253	24"	36"	29"
Basic	WBW2448XX9NWS	\$272	24"	48"	29"
Basic	WBW2460XX9NWS	\$291	24"	60"	29"
Basic	WBW2472XX9NWS	\$335	24"	72"	29"
Basic	WBW3036XX9NWS	\$265	30"	36"	29"
Basic	WBW3048XX9NWS	\$277	30"	48"	29"
Basic	WBW3060XX9NWS	\$296	30"	60"	29"
Basic	WBW3072XX9NWS	\$314	30"	72"	29"
* Basic	WBW2436XX9WWS	\$267	24"	36"	29"
* Basic	WBW2448XX9WWS	\$292	24"	48"	29"
* Basic	WBW2460XX9WWS	\$315	24"	60"	29"
* Basic	WBW2472XX9WWS	\$248	24"	72"	29"
* Basic	WBW3036XX9WWS	\$280	30"	36"	29"
* Basic	WBW3048XX9WWS	\$295	30"	48"	29"
* Basic	WBW3060XX9WWS	\$321	30"	60"	29"
* Basic	WBW3072XX9WWS	\$340	30"	72"	29"

Stand-Up Worksurface

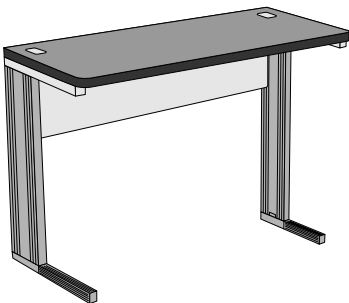

Standard Features

- 1 1/4" solid core top with high pressure laminate finish
- Please specify edge type: T-mold or 3mm PVC
- Each leg is a welded unit joined by a modesty panel; leg cavity provides concealed management of wire from floor to worksurface
- 16 gauge seam-welded tubular steel frame with 19 gauge steel modesty panel
- 3" x 2" wire management port with protected edges, on both sides at top of modesty panel
- Non-chipping enamel finish on legs and modesty
- Scuff plates
- Adjustable chrome plated leveling glides
- Two grommets

* Includes wireway trough affixed to top of modesty panels

Type	Model#	Price	D	W	H
Stand-Up	WSU3036XX2NWS	\$273	30"	36"	42"
* Stand-Up	WSU3036XX2WWS	\$288	30"	36"	42"

Typical Metal Base Workstations FlexStation

Required for Order: Model number, Laminate finish choice, Edge type choice, Trim color choice

Corner Worksurface

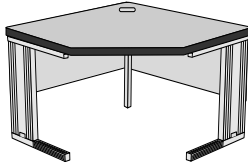

Standard Features

- 1 1/4" solid core top with high pressure laminate finish
- Please specify edge type: T-mold or 3mm PVC
- Each leg is a welded unit joined by a modesty panel; full leg cavity provides concealed management of wire from floor to worksurface
- 16 gauge seam-welded tubular steel frame with 19 gauge steel full wrap modesty panel
- 3" x 2" wire management port with protected edges, on both sides at top of modesty panels
- Non-chipping enamel finish on legs and modesty
- Scuff plates
- Adjustable chrome plated leveling glides
- Single grommet located in corner
- * Includes wireway trough affixed to top of modesty panels

Type	Model#	Price	Left D x W	Right W x D	H
Stand alone, corner	WCS2436XX9NWS	\$364	24" x 36"	36" x 24"	29"
Stand alone, corner	WCS2442XX9NWS	\$386	24" x 42"	42" x 24"	29"
Stand alone, corner	WCS2448XX9NWS	\$409	24" x 48"	48" x 24"	29"
Stand alone, corner	WCS3042XX9NWS	\$431	30" x 42"	42" x 30"	29"
Stand alone, corner	WCS3048XX9NWS	\$453	30" x 48"	48" x 30"	29"
* Stand alone, corner	WCS2436XX9WWS	\$392	24" x 36"	36" x 24"	29"
* Stand alone, corner	WCS2442XX9WWS	\$419	24" x 42"	42" x 24"	29"
* Stand alone, corner	WCS2448XX9WWS	\$446	24" x 48"	48" x 24"	29"
* Stand alone, corner	WCS3042XX9WWS	\$464	30" x 42"	42" x 30"	29"
* Stand alone, corner	WCS3048XX9WWS	\$493	30" x 48"	48" x 30"	29"

Reduction Worksurface

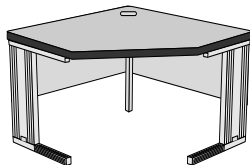

Standard Features

- 1 1/4" solid core top with high pressure laminate finish
- Please specify edge type: T-mold or 3mm PVC
- Each leg is a welded unit joined by a modesty panel; full leg cavity provides concealed management of wire from floor to worksurface
- 16 gauge seam-welded tubular steel frame with 19 gauge steel full wrap modesty panel
- 3" x 2" wire management port with protected edges, on both sides at top of modesty panels
- Non-chipping enamel finish on legs and modesty
- Scuff plates
- Adjustable chrome plated leveling glides
- Single grommet located in corner
- * Includes wireway trough affixed to top of modesty panels

Type	Model#	Price	Left D x W	Right W x D	H
Stand alone, corner reduction	WCS244230XX9NWS	\$399	24" x 42"	42" x 30"	29"
Stand alone, corner reduction	WCS244830XX9NWS	\$431	24" x 48"	48" x 30"	29"
Stand alone, corner reduction	WCS304224XX9NWS	\$399	30" x 42"	42" x 24"	29"
Stand alone, corner reduction	WCS304824XX9NWS	\$431	30" x 48"	48" x 24"	29"
* Stand alone, corner reduction	WCS244230XX9WWS	\$431	24" x 42"	42" x 30"	29"
* Stand alone, corner reduction	WCS244830XX9WWS	\$469	24" x 48"	48" x 30"	29"
* Stand alone, corner reduction	WCS304224XX9WWS	\$431	30" x 42"	42" x 24"	29"
* Stand alone, corner reduction	WCS304824XX9WWS	\$469	30" x 48"	48" x 24"	29"

FlexStation Typical Metal Base Workstations

Required for Order: Model number, Laminate finish choice, Edge type choice, Trim color choice

Corner Curvilinear Worksurface

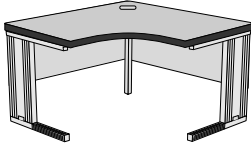

Standard Features

- 1 1/4" solid core top with high pressure laminate finish
- Please specify edge type: T-mold or 3mm PVC
- Each leg is a welded unit joined by a modesty panel; full leg cavity provides concealed management of wire from floor to worksurface
- 16 gauge seam-welded tubular steel frame with 19 gauge steel full wrap modesty panel
- 3" x 2" wire management port with protected edges, on both sides at top of modesty panels
- Non-chipping enamel finish on legs and modesty
- Scuff plates
- Adjustable chrome plated leveling glides
- Single grommet located in corner

* Includes wireway trough affixed to top of modesty panels

Type	Model#	Price	Left D x W	Right W x D	H
Stand alone, corner	WCC243624XX9NWS	\$392	24" x 36"	36" x 24"	29"
Stand alone, corner	WCC244224XX9NWS	\$386	24" x 42"	42" x 24"	29"
Stand alone, corner	WCC244824XX9NWS	\$409	24" x 48"	48" x 24"	29"
Stand alone, corner	WCC304230XX9NWS	\$431	30" x 42"	42" x 30"	29"
Stand alone, corner	WCC304830XX9NWS	\$453	30" x 48"	48" x 30"	29"
* Stand alone, corner	WCC243624XX9WWS	\$392	24" x 36"	36" x 24"	29"
* Stand alone, corner	WCC244224XX9WWS	\$419	24" x 42"	42" x 24"	29"
* Stand alone, corner	WCC244824XX9WWS	\$446	24" x 48"	48" x 24"	29"
* Stand alone, corner	WCC304230XX9WWS	\$464	30" x 42"	42" x 30"	29"
* Stand alone, corner	WCC304830XX9WWS	\$493	30" x 48"	48" x 30"	29"

Curvilinear Reduction Worksurface

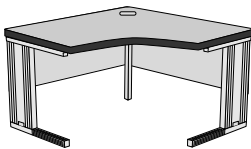

Standard Features

- 1 1/4" solid core top with high pressure laminate finish
- Please specify edge type: T-mold or 3mm PVC
- Each leg is a welded unit joined by a modesty panel; full leg cavity provides concealed management of wire from floor to worksurface
- 16 gauge seam-welded tubular steel frame with 19 gauge steel full wrap modesty panel
- 3" x 2" wire management port with protected edges, on both sides at top of modesty panels
- Non-chipping enamel finish on legs and modesty
- Scuff plates
- Adjustable chrome plated leveling glides
- Single grommet located in corner

* Includes wireway trough affixed to top of modesty panels

Type	Model#	Price	Left D x W	Right W x D	H
Stand alone, corner reduction	WCCS244230XX9NWS	\$399	24" x 42"	42" x 30"	29"
Stand alone, corner reduction	WCCS244830XX9NWS	\$431	24" x 48"	48" x 30"	29"
Stand alone, corner reduction	WCCS304224XX9NWS	\$399	30" x 42"	42" x 24"	29"
Stand alone, corner reduction	WCCS304824XX9NWS	\$431	30" x 48"	48" x 24"	29"
* Stand alone, corner reduction	WCCS244230XX9WWS	\$431	24" x 42"	42" x 30"	29"
* Stand alone, corner reduction	WCCS244830XX9WWS	\$469	24" x 48"	48" x 30"	29"
* Stand alone, corner reduction	WCCS304224XX9WWS	\$431	30" x 42"	42" x 24"	29"
* Stand alone, corner reduction	WCCS304824XX9WWS	\$469	30" x 48"	48" x 24"	29"

Typical Metal Base Workstations FlexStation

Required for Order: Model number, Laminate finish choice, Edge type choice (Piano Peninsula available in T-mold only), Trim color choice

Transitional Worksurface

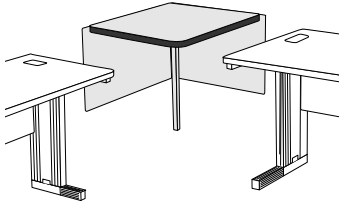

Standard Features

- 1 1/4" solid core top with high pressure laminate finish
- Please specify edge type: T-mold or 3mm PVC
- Two splice plates provided
- Metal post leg is joined with modesty panels
- 16 gauge seam-welded tubular steel frame with 19 gauge steel full wrap modesty panel
- Non-chipping enamel finish on leg and modesty
- * Includes wireway trough affixed to top of modesty panels

NOTE: Scheduled installation required. Additional charge will apply (includes inside delivery).

Type	Model#	Price	D	W	H
Transitional corner, square	WST2424XXX99NW	\$136	24"	24"	29"
Transitional corner, square	WST3030XXX99NW	\$169	30"	30"	29"
Transitional corner, rectangle	WRT2430XXX99NW	\$162	24"	30"	29"
Transitional corner, rectangle	WRT3024XXX99NW	\$162	30"	24"	29"
* Transitional corner, square	WST2424XXX99WW	\$162	24"	24"	29"
* Transitional corner, square	WST3030XXX99WW	\$197	30"	30"	29"
* Transitional corner, rectangle	WRT2430XXX99WW	\$187	24"	30"	29"
* Transitional corner, rectangle	WRT3024XXX99WW	\$187	30"	24"	29"

Piano Peninsula Worksurface

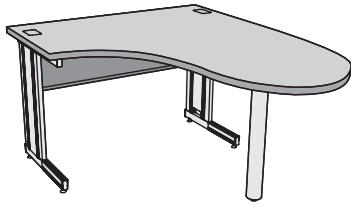

(right shown)

Standard Features

- 1 1/4" solid core top with high pressure laminate finish
- Edge available in T-mold only
- Two legs are welded units joined by a modesty panel; leg cavity provides concealed management of wire from floor to worksurface
- 3" diameter metal support leg
- 16 gauge seam-welded tubular steel frame with 19 gauge steel modesty panel
- 3" x 2" wire management port with protected edges, on bot sides at top of modesty panel
- Non-chipping enamel finish on legs and modesty
- Scuff plates
- Adjustable chrome plated leveling glides
- Two grommets
- * Includes wireway trough affixed to top of modesty panels

Type	Model#	Price	D	W	H
Peninsula, piano left	WZPP244860XXL9NWS	\$514	24"	48"	29"
Peninsula, piano right	WZPP244860XXR9NWS	\$514	24"	48"	29"
Peninsula, piano left	WZPP244872XXL9NWS	\$517	24"	48"	29"
Peninsula, piano right	WZPP244872XXR9NWS	\$517	24"	48"	29"
Peninsula, piano left	WZPP304872XXL9NWS	\$523	30"	48"	29"
Peninsula, piano right	WZPP304872XXR9NWS	\$523	30"	48"	29"
* Peninsula, piano left	WZPP244860XXL9WWS	\$533	24"	48"	29"
* Peninsula, piano right	WZPP244860XXR9WWS	\$533	24"	48"	29"
* Peninsula, piano left	WZPP244872XXL9WWS	\$537	24"	48"	29"
* Peninsula, piano right	WZPP244872XXR9WWS	\$537	24"	48"	29"
* Peninsula, piano left	WZPP304872XXL9WWS	\$540	30"	48"	29"
* Peninsula, piano right	WZPP304872XXR9WWS	\$540	30"	48"	29"

FlexStation Typical Metal Base Workstations

Required for Order: Model number, Laminate finish choice, Trim color choice

Peninsula End Mount Worksurface

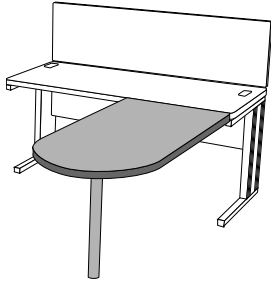

Standard Features

- 1 1/4" solid core top with high pressure laminate finish
- Edge available in T-mold only
- Non-chipping enamel finish on 3" diameter metal support leg
- Two splice plates provided
- No wire management available

NOTE: Scheduled installation required. Additional charge will apply (includes inside delivery).

Type	Model#	Price	D	W	H
Peninsula, end mount	WPW2448XX9NW	\$220	24"	48"	29"
Peninsula, end mount	WPW2460XX9NW	\$234	24"	60"	29"
Peninsula, end mount	WPW3048XX9NW	\$223	30"	48"	29"
Peninsula, end mount	WPW3060XX9NW	\$239	30"	60"	29"

Peninsula Side Mount Worksurface

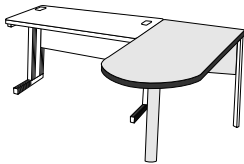

(Right Leg Peninsula)

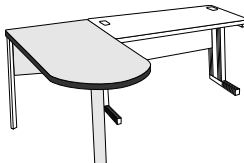

(Left Leg Peninsula)

Standard Features

- 1 1/4" solid core top with high pressure laminate finish
- Edge available in T-mold only
- 3" diameter metal support leg with adjustable chrome plated leveling glide
- Metal post leg, joined with a modesty panel
- 16 gauge seam-welded tubular steel frame with 19 gauge steel modesty panel
- Non-chipping enamel finish on legs and modesty
- Two splice plates provided
- No wire management available
- Specify **right** or **left** leg

NOTE: Scheduled installation required. Additional charge will apply (includes inside delivery).

Type	Model#	Price	D	W	H
Peninsula, side mount	WPW2448-SXX9NW	\$239	24"	48"	29"
Peninsula, side mount	WPW2460-SXX9NW	\$255	24"	60"	29"
Peninsula, side mount	WPW2472-SXX9NW	\$270	24"	72"	29"
Peninsula, side mount	WPW3048-SXX9NW	\$243	30"	48"	29"
Peninsula, side mount	WPW3060-SXX9NW	\$259	30"	60"	29"
Peninsula, side mount	WPW3072-SXX9NW	\$277	30"	72"	29"

Conference Worksurface

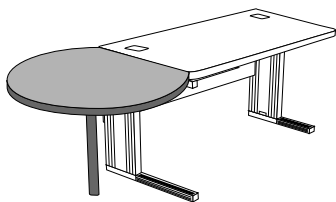

Standard Features

- 1 1/4" solid core top with high pressure laminate finish
- Edge available in T-mold only
- 3" diameter metal support leg with adjustable chrome plated leveling glide
- Non-chipping enamel finish on leg
- Includes splice plates
- No wire management available

NOTE: Scheduled installation required. Additional charge will apply (includes inside delivery).

Type	Model#	Price	D	Dia	H
Conference, end for 24" worksurface	WCE36XX9	\$188	24"	36"	29"
Conference, end for 30" worksurface	WCE42XX9	\$196	30"	42"	29"

Overheads **FlexStation**

Required for Order: Model number, Laminate finish choice, Fabric choice (on cabinets w/ fabric doors), Trim color choice

Universal Overhead Cabinet

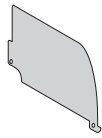
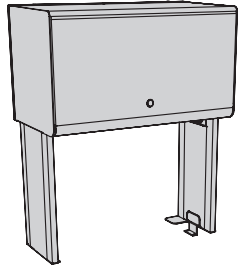

NSD

Standard Features

- Steel construction with powder coat finish
- Locking door(s) with steel, laminate or fabric face
- Doors store recessed with handle exposed
- 72" overhead has 36" doors and middle support upright
- Shelf depth is 13.25"
- Concealed vertical wire management
- Secured to worksurface by concealed mounting brackets
- Steel shelf divider fits all WZUS, WZUF, WZUL and WUSS overheads (specify powder coat finish choice)

NOTE: Scheduled installation required. Additional charge will apply (includes inside delivery).

Type	Model#	Price	D	W	H
Single door, steel door	WZUS36	\$328	14.5"	36"	36"
Single door, steel door	WZUS48	\$343	14.5"	48"	36"
Single door, steel door	WZUS60	\$406	14.5"	60"	36"
Double door, steel doors	WZUS72	\$587	14.5"	72"	36"
Single door, fabric door	WZUF36	\$357	14.5"	36"	36"
Single door, fabric door	WZUF48	\$375	14.5"	48"	36"
Single door, fabric door	WZUF60	\$437	14.5"	60"	36"
Double door, fabric doors	WZUF72	\$645	14.5"	72"	36"
Single door, laminate door	WZUL36	\$359	14.5"	36"	36"
Single door, laminate door	WZUL48	\$386	14.5"	48"	36"
Single door, laminate door	WZUL60	\$444	14.5"	60"	36"
Double door, laminate doors	WZUL72	\$655	14.5"	72"	36"
Shelf divider	NSD	\$ 7	-	7.25"	11.5"

Universal Overhead Shelf

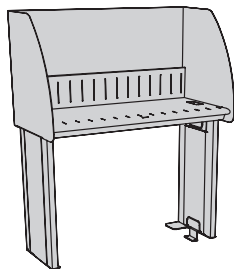

Standard Features

- Steel construction with powder coat finish
- 72" overhead has 36" doors and middle support upright
- Shelf depth is 13.25"
- Concealed vertical wire management
- Secured to worksurface by concealed mounting brackets

NOTE: Scheduled installation required. Additional charge will apply (includes inside delivery).

Type	Model#	Price	D	W	H
Open shelf	WUSS36	\$233	13.25"	36"	36"
Open shelf	WUSS48	\$243	13.25"	48"	36"
Open shelf	WUSS60	\$259	13.25"	60"	36"
Open shelf	WUSS72	\$393	13.25"	72"	36"

FlexStation Privacy Screens

Required for Order: Model number, Fabric choice (for privacy screens), Trim color choice (for privacy screen brackets)

Worksurface Privacy Screen

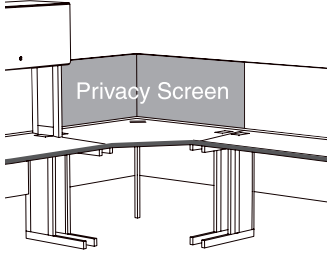

Standard Features

- Upholstered w/ soil resistant fabric
- Painted steel mounting brackets
- Not for use on worksurfaces with overhead cabinets

NOTE: Scheduled installation required. Additional charge will apply (includes inside delivery).

Type	Model#	Price	W	H
For basic worksurface	WZP36	\$147	36"	19"
For basic worksurface	WZP48	\$164	48"	19"
For basic worksurface	WZP60	\$255	60"	19" (two screens)
For basic worksurface	WZP72	\$263	72"	19" (two screens)
For stand alone, corner worksurface	WZPC2442	\$355	42"	19" (two screens)
For stand alone corner worksurface	WZPC3048	\$362	48"	19" (two screens)
For transitional corner 24" square	WZPS2424	\$179	24"	19" (two screens)
For transitional corner 30" square	WZPS3030	\$187	30"	19" (two screens)
For transitional corner rectangle	WZPR3024	\$139	30"/24"	19" (two screens)

Worksurface Privacy Screen

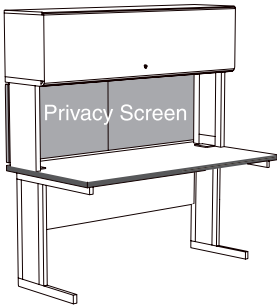

Standard Features

- Upholstered w/ soil resistant fabric
- Painted steel mounting brackets
- For use on worksurfaces with overhead cabinets only

NOTE: Scheduled installation required. Additional charge will apply (includes inside delivery).

Type	Model#	Price	W	H
For overhead cabinets	WZOP36	\$155	36"	19"
For overhead cabinets	WZOP48	\$181	48"	19"
For overhead cabinets	WZOP60	\$267	60"	19" (two screens)
For overhead cabinets	WZOP72	\$280	72"	19" (two screens)

Task Light

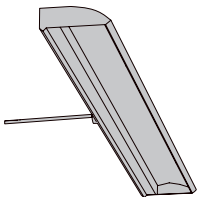

Standard Features

- Task light attaches to the underside of overhead shelf
- Slim, energy efficient T5 fluorescent 3500K lamp
- Standard normal power factor, electronic ballast
- UL and CUL listed
- Available in black only

NOTE: Scheduled installation required. Additional charge will apply (includes inside delivery).

Type	Model#	Price	Light W	Fits Overhead W
Task light for overheads	LT24	\$46	24"	30" & 36"
Task light for overheads	LT36	\$48	36"	42" & 48"
Task light for overheads	LT48	\$55	48"	60" & 72"

Work Bar Accessories FlexStation

Required for Order: Model number, Trim color choice

Work Bar

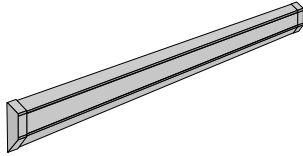

Standard Features

- Accommodates paper management components
- Attaches between overhead uprights, field installable
- Fits only Area Design and FlexStation shared overhead units
- Painted aluminum construction

Type	Model#	Price	D	W	H
Work bar	WWB36	\$41	-	36"	-
Work bar	WWB48	\$48	-	48"	-
Work bar	WWB60	\$52	-	60"	-
Work bar	WWB72	\$60	-	72"	-

Hanging Rails

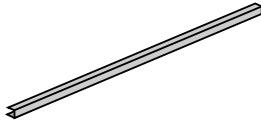

Standard Features

- Suspends letter or legal paper trays from underside of WOC overheads
- Cannot be used with task light on overhead unit

Type	Model#	Price
Hanging rails (one pair)	WHR	\$19

Paper Management

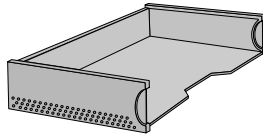

Standard Features

- Plastic and metal construction
- Letter or legal size, stackable
- Suspends from workbar or hanging rails
- Suitable for freestanding worksurface or overhead location

Type	Model#	Price	D	W	H
Letter Paper tray	PMHLT	\$37	19.25"	13.25"	3"
Legal Paper tray	PMHLG	\$37	19.25"	16.25"	3"

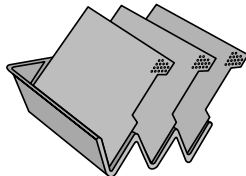

Standard Features

- Plastic and metal construction, suspends only from work bar
- Suitable for freestanding worksurface or overhead location
- Three slanted partitions per unit, with ID clips

Type	Model#	Price	D	W	H
Slanted storage	PMD	\$65	12.5"	10.5"	7.75"

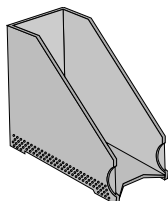

Standard Features

- Plastic and metal construction, includes identification clips
- Suspends only from work bar
- Suitable for freestanding worksurface or overhead location

Type	Model#	Price	D	W	H
Binder bin	PMV	\$44	12.25"	5"	9.5"

Additional Products

Basic Worksurfaces

Type	Model#	W	L/R D	H
Curvilinear Worksurface	WRC244230XX9NWS	42"	24"/30"	29"
Curvilinear Worksurface	WRC244830XX9NWS	48"	24"/30"	29"
Curvilinear Worksurface	WRC245430XX9NWS	54"	24"/30"	29"
Curvilinear Worksurface	WRC246030XX9NWS	60"	24"/30"	29"
Curvilinear Worksurface	WRC247230XX9NWS	72"	24"/30"	29"
Curvilinear Worksurface	WRC304224XX9NWS	42"	30"/24"	29"
Curvilinear Worksurface	WRC304824XX9NWS	48"	30"/24"	29"
Curvilinear Worksurface	WRC305424XX9NWS	54"	30"/24"	29"
Curvilinear Worksurface	WRC306024XX9NWS	60"	30"/24"	29"
Curvilinear Worksurface	WRC307224XX9NWS	72"	30"/24"	29"

Transitional Corner, Triangle	WTT2424XX99NW	34"	24"/24"	29"
Transitional Corner, Triangle	WTT3030XX99NW	42"	30"/30"	29"
Transitional Corner, Quarter Round	WQR24XX99	-	24"/24"	29"
Transitional Corner, Quarter Round	WQR30XX99	-	30"/30"	29"
Trans. Corner Q. R. for panel	WQRP24XX99	-	24"/24"	29"
Trans. Corner Q. R. for panel	WQRP30XX99	-	30"/30"	29"

		W	D	H
Basic Worksurface	WBW2430XX9NWS	30"	24"	29"
Basic Worksurface	WBW2442XX9NWS	42"	24"	29"
Basic Worksurface	WBW2454XX9NWS	54"	24"	29"
Basic Worksurface	WBW3030XX9NWS	30"	30"	29"
Basic Worksurface	WBW3042XX9NWS	42"	30"	29"
Basic Worksurface	WBW3054XX9NWS	54"	30"	29"

Basic w/ Adj. Keyboard Pad	WAK2436XXC9NWS	36"	24"	29"
Basic w/ Adj. Keyboard Pad	WAK2442XXC9NWS	42"	24"	29"
Basic w/ Adj. Keyboard Pad	WAK2448XXC9NWS	48"	24"	29"
Basic w/ Adj. Keyboard Pad	WAK2454XXC9NWS	54"	24"	29"
Basic w/ Adj. Keyboard Pad	WAK2460XXC9NWS	60"	24"	29"
Basic w/ Adj. Keyboard Pad	WAK2472XXC9NWS	72"	24"	29"
Basic w/ Adj. Keyboard Pad	WAK3036XXC9NWS	36"	30"	29"
Basic w/ Adj. Keyboard Pad	WAK3042XXC9NWS	42"	30"	29"
Basic w/ Adj. Keyboard Pad	WAK3048XXC9NWS	48"	30"	29"
Basic w/ Adj. Keyboard Pad	WAK3054XXC9NWS	54"	30"	29"
Basic w/ Adj. Keyboard Pad	WAK3060XXC9NWS	60"	30"	29"
Basic w/ Adj. Keyboard Pad	WAK3072XXC9NWS	72"	30"	29"

		W	L/R D	H
Basic Corner w/ Adj. Keyboard Pad	WCSK2442XX9NWS	42"	24"/24"	29"
Basic Corner w/ Adj. Keyboard Pad	WCSK2448XX9NWS	48"	24"/24"	29"
Basic Corner w/ Adj. Keyboard Pad	WCSK3048XX9NWS	48"	30"/30"	29"

Basic Worksurfaces

		W	D/L	H
"P" Shaped Peninsula Right	WZPT244860XXR9NWS	48"	24"/60"	29"
"P" Shaped Peninsula Left	WZPT244860XXL9NWS	48"	24"/60"	29"
"P" Shaped Peninsula Right	WZPT244872XXR9NWS	48"	24"/72"	29"
"P" Shaped Peninsula Left	WZPT244872XXL9NWS	48"	24"/72"	29"
"P" Shaped Peninsula Right	WZPT304872XXR9NWS	48"	30"/72"	29"
"P" Shaped Peninsula Left	WZPT304872XXL9NWS	48"	30"/72"	29"
Square Shoe Worksurface Right	WZSS244860XXR9NW	48"	24"/60"	29"
Square Shoe Worksurface Left	WZSS244860XXL9NW	48"	24"/60"	29"
Square Shoe Worksurface Right	WZSS244866XXR9NW	48"	24"/66"	29"
Square Shoe Worksurface Left	WZSS244866XXL9NW	48"	24"/66"	29"
Square Shoe Worksurface Right	WZSS244872XXR9NW	48"	24"/72"	29"
Square Shoe Worksurface Left	WZSS244872XXL9NW	48"	24"/72"	29"
Square Shoe Worksurface Right	WZSS244884XXR9NW	48"	24"/84"	29"
Square Shoe Worksurface Left	WZSS244884XXL9NW	48"	24"/84"	29"
Square Shoe Worksurface Right	WZSS304866XXR9NW	48"	30"/66"	29"
Square Shoe Worksurface Left	WZSS304866XXL9NW	48"	30"/66"	29"
Square Shoe Worksurface Right	WZSS304872XXR9NW	48"	30"/72"	29"
Square Shoe Worksurface Left	WZSS304872XXL9NW	48"	30"/72"	29"
Square Shoe Worksurface Right	WZSS304884XXR9NW	48"	30"/84"	29"
Square Shoe Worksurface Left	WZSS304884XXL9NW	48"	30"/84"	29"

		D	Dia.	H
Mobile Teardrop Worksurface	WMT2440XX9G	24"	40"	29"
Mobile Teardrop Worksurface	WMT3050XX9G	30"	50"	29"
Mobile Teardrop for panel	WMTP2445XX9G	24"	45"	29"
Mobile Teardrop for panel	WMTP3055XX9G	30"	55"	29"
Mobile Semi-Circle Worksurface	WMSC48XX9G	24"	48"	29"
Mobile Semi-Circle Worksurface	WMSC60XX9G	30"	60"	29"
Mobile Semi-Circle for panel	WMSCP51XX9G	24"	50.5"	29"
Mobile Semi-Circle for panel	WMSCP63XX9G	30"	62.5"	29"

		W	D	H
Peninsula, End Mount	WPW2472XX9NW	72"	24"	29"
Peninsula, End Mount	WPW3072XX9NW	72"	30"	29"
Peninsula, Center Mount	WPW2448-CXX9NW	48"	24"	29"
Peninsula, Center Mount	WPW2460-CXX9NW	60"	24"	29"
Peninsula, Center Mount	WPW2472-CXX9NW	72"	24"	29"

		W	D	H
Peninsula, Center Mount	WPW3048-CXX9NW	48"	30"	29"
Peninsula, Center Mount	WPW3060-CXX9NW	60"	30"	29"
Peninsula, Center Mount	WPW3072-CXX9NW	72"	30"	29"

		W	L/R D	H
Corner Transitional Surface	WCT2436XX99NW	36"	24"/24"	29"
Corner Transitional Surface	WCT2442XX99NW	42"	24"/24"	29"
Corner Transitional Surface	WCT2448XX99NW	48"	24"/24"	29"
Corner Transitional Surface	WCT3042XX99NW	42"	30"/30"	29"
Corner Transitional Surface	WCT3048XX99NW	48"	30"/30"	29"
Corner Transitional w/ Keyboard	WCTK2442XX99NW	42"	24"/24"	29"
Corner Transitional w/ Keyboard	WCTK2448XX99NW	48"	24"/24"	29"
Corner Transitional w/ Keyboard	WCTK3048XX99NW	48"	30"/30"	29"

This list is a complement to the items found on pages 2 through 11.

For pricing, call for a quote.

Additional Products

Basic Worksurfaces

Type	Model#	W	D	H
Corner Transitional Reduction	WCT244230XX99NW	42"	24"/30"	29"
Corner Transitional Reduction	WCT244830XX99NW	48"	24"/30"	29"
Corner Transitional Reduction	WCT304224XX99NW	42"	30"/24"	29"
Corner Transitional Reduction	WCT304824XX99NW	48"	30"/24"	29"
Corner Curvilinear Transitional	WCCT2436XX99NW	36"	24"/24"	29"
Corner Curvilinear Transitional	WCCT2442XX99NW	42"	24"/24"	29"
Corner Curvilinear Transitional	WCCT2448XX99NW	48"	24"/24"	29"
Corner Curvilinear Transitional	WCCT3042XX99NW	42"	30"/30"	29"
Corner Curvilinear Transitional	WCCT3048XX99NW	48"	30"/30"	29"
Corner Curv. Transitional Reduction	WCCT244230XX99NW	42"	24"/30"	29"
Corner Curv. Transitional Reduction	WCCT244830XX99NW	48"	24"/30"	29"
Corner Curv. Transitional Reduction	WCCT304224XX99NW	42"	30"/24"	29"
Corner Curv. Transitional Reduction	WCCT304824XX99NW	48"	30"/24"	29"
End-of-Run Corner Surface Right	WER2436XXR9NW	36"	24"/24"	29"
End-of-Run Corner Surface Left	WER2436XXL9NW	36"	24"/24"	29"
End-of-Run Corner Surface Right	WER2442XXR9NW	42"	24"/24"	29"
End-of-Run Corner Surface Left	WER2442XXL9NW	42"	24"/24"	29"
End-of-Run Corner Surface Right	WER2448XXR9NW	48"	24"/24"	29"
End-of-Run Corner Surface Left	WER2448XXL9NW	48"	24"/24"	29"
End-of-Run Corner Surface Right	WER3042XXR9NW	42"	30"/30"	29"
End-of-Run Corner Surface Left	WER3042XXL9NW	42"	30"/30"	29"
End-of-Run Corner Surface Right	WER3048XXR9NW	48"	30"/30"	29"
End-of-Run Corner Surface Left	WER3048XXL9NW	48"	30"/30"	29"
End-of-Run Corner w/ Keyboard Right	WERK2442XXR9NW	42"	24"/24"	29"
End-of-Run Corner w/ Keyboard Left	WERK2442XXL9NW	42"	24"/24"	29"
End-of-Run Corner w/ Keyboard Right	WERK2448XXR9NW	48"	24"/24"	29"
End-of-Run Corner w/ Keyboard Left	WERK2448XXL9NW	48"	24"/24"	29"
End-of-Run Corner w/ Keyboard Right	WERK3048XXR9NW	48"	30"/30"	29"
End-of-Run Corner w/ Keyboard Left	WERK3048XXL9NW	48"	30"/30"	29"
End-of-Run Corner Curvilinear Right	WCCE2436XXR9NW	36"	24"/24"	29"
End-of-Run Corner Curvilinear Left	WCCE2436XXL9NW	36"	24"/24"	29"
End-of-Run Corner Curvilinear Right	WCCE2442XXR9NW	42"	24"/24"	29"
End-of-Run Corner Curvilinear Left	WCCE2442XXL9NW	42"	24"/24"	29"
End-of-Run Corner Curvilinear Right	WCCE2448XXR9NW	48"	24"/24"	29"
End-of-Run Corner Curvilinear Left	WCCE2448XXL9NW	48"	24"/24"	29"
End-of-Run Corner Curvilinear Right	WCCE3042XXR9NW	42"	30"/30"	29"
End-of-Run Corner Curvilinear Left	WCCE3042XXL9NW	42"	30"/30"	29"
			L/R	
		W	D	H
End-of-Run Corner Curvilinear Right	WCCE3048XXR9NW	48"	30"/30"	29"
End-of-Run Corner Curvilinear Left	WCCE3048XXL9NW	48"	30"/30"	29"

Basic Worksurface Components

Type	Model#	W	D	H
Universal Printer Stand	WUP24277	27.5"	24"	27"
Basic Printer Stand	WBP24309NWS	30"	24"	29"
Basic Printer Stand	WBP30369NWS	36"	30"	29"
Receiver Basket	WRB3121	21.5"	31"	-

Overheads

Type	Model#	W	D	H
Single Door, steel door	WZUS30	30"	14.5"	36"
Single Door, steel door	WZUS42	42"	14.5"	36"
Single Door, steel door	WZUS54	54"	14.5"	36"
Double Door, steel doors	WZUS66	66"	14.5"	36"
Single Door, fabric door	WZUF30	30"	14.5"	36"
Single Door, fabric door	WZUF42	42"	14.5"	36"
Single Door, fabric door	WZUF54	54"	14.5"	36"
Double Door, fabric doors	WZUF66	66"	14.5"	36"
Single Door, laminate door	WZUL30	30"	14.5"	36"
Single Door, laminate door	WZUL42	42"	14.5"	36"
Single Door, laminate door	WZUL54	54"	14.5"	36"
Double Door, laminate doors	WZUL66	66"	14.5"	36"
Open Shelf	WUSS30	30"	13.25"	36"
Open Shelf	WUSS42	42"	13.25"	36"
Open Shelf	WUSS54	54"	13.25"	36"
Open Shelf	WUSS66	66"	13.25"	36"

Privacy Screens

Type	Model#	W	D	H
Worksurface Privacy Screen	WZP24	24"	-	19"
Worksurface Privacy Screen	WZP30	30"	-	19"
Worksurface Privacy Screen	WZP42	42"	-	19"
Worksurface Privacy Screen	WZP54	54"	-	19"
P.S. for Transitional Corner (2)	WZPC2436	36"	-	19"
P.S. for Transitional Triangle (1)	WZPT3030	30"	-	19"
P.S. for Overhead Cabinet	WZOP24	24"	-	19"
P.S. for Overhead Cabinet	WZOP30	30"	-	19"
P.S. for Overhead Cabinet	WZOP42	42"	-	19"
P.S. for Overhead Cabinet	WZOP54	54"	-	19"

This list is a complement to the items found on pages 2 through 11.

For pricing, call for a quote.

Additional Products

Basic Worksurface Accessories

Type	Model#	W	D	H
Tool Rail	PMTR30	30"	-	4.5"
Tool Rail	PMTR36	36"	-	4.5"
Tool Rail	PMTR42	42"	-	4.5"
Tool Rail	PMTR48	48"	-	4.5"
Tool Rail	PMTR54	54"	-	4.5"
Tool Rail	PMTR60	60"	-	4.5"
Tool Rail	PMTR72	72"	-	4.5"
Hanging Folder Holder	PFH	1"	8.5"	2"
Paper Tray	PLL	9.5"	14"	2"
Diagonal Storage	PDS	7"	12.5"	2.5"
Vertical Storage	PVS	5"	10.5"	9"
Telephone Caddy	PTC	8.5"	9.5"	2"
CD Holder	PDH	5.5"	7"	2"
Accessory Tray	PAT	9.5"	10"	2"
Pencil Cup	PPC	4"	3.5"	4"
Work Bar	WWB30	30"	-	-
Work Bar	WWB42	42"	-	-
Work Bar	WWB54	54"	-	-
CPU Sling	CPU-SLING	5.375"	18"	-

		Fits Computer w/	H	W	Max. D
Adjustable CPU Holder	ACPUNLOCK	11"-21"	2"-10.5"	-	-
Adjustable CPU Holder w/ cover	ACPUWLOCK	11"-21"	2"-10.5"	-	-
Adj. CPU Holder w/ cover & lock	ACPUWLOCK	11"-21"	2"-10.5"	16"	-

		W	D	H
CPU Covers	ACPU-CK			
CPU Security Kit for use w/ covers	ACPU-SK			
CPU Extra Cable for Security Kit	ACPU-CABLE			
Manuscript Stand	WMS	8"	12"	-
Turntable	WTN1518	15"	18"	-
Turntable	WTN2024	20"	24"	-

This list is a complement to the items found on pages 2 through 11.

For pricing, call for a quote.



WASHINGTON STATE
CORRECTIONAL INDUSTRIES

Department of Corrections
PO Box 41115
Olympia, Washington 98504